



QS18 Series Sensor Product Manual

Original Instructions
p/n: 197052 Rev. H
12-Aug-25

© Banner Engineering Corp. All rights reserved. www.bannerengineering.com

Contents

Chapter 1 Features	3
Models	3
Specifications	4
FCC Part 15 Class A for Unintentional Radiators	5
Industry Canada ICES-003(A)	5
Dimensions	6
Performance Curves	7
Chapter 2 Installation Instructions	14
Wiring Diagrams	14
Installing Fibers	14
Cutting Unterminated Plastic Fibers	14
Install the Plastic Fibers	15
Install the Glass Fibers	15
Mount the Device	15
Chapter 3 Operating Instructions	17
Sensor Sensitivity Adjustment	17
Chapter 4 QS18 Accessories.....	18
Cordsets	18
Sensor Status Indicators	19
QS18 Brackets	19
Retroreflective Targets.....	19
Plastic and Glass Fiber Optics	20
Chapter 5 Product Support and Maintenance	21
Clean Sensor with Compressed Air Then Isopropyl Alcohol	21
Repairs	21
Contact Us	21
Banner Engineering Corp Limited Warranty	21

Chapter Contents

Models 3
 Specifications 4

Chapter 1 Features

Miniature self-contained photoelectric sensor in a universal housing

- Easily fits (or retrofits) almost any mounting situation
- Exceptional optical performance, comparable to larger “MINI-style” or barrel sensors
- 10 V DC to 30 V DC operation, with complementary (SPDT) NPN or PNP outputs, depending on model
- Bright LED operating status indicators are visible from 360°
- Rugged sealed housing, protected circuitry
- Models available with or without 18 mm threaded “nose”
- Less than 1-millisecond output response for excellent sensing repeatability
- Choose 2 m (6.5 ft), 9 m (30 ft), or 150 mm (6 in) cable with a M8 quick disconnect connector

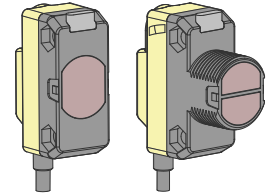

WARNING:



- **Do not use this device for personnel protection**
- Using this device for personnel protection could result in serious injury or death.
- This device does not include the self-checking redundant circuitry necessary to allow its use in personnel safety applications. A device failure or malfunction can cause either an energized (on) or de-energized (off) output condition.

Models

Model	Opposed Mode	Range	Output
QS186EV (624 nm Visible red)	Effective beam: 13 mm (0.5 inch)	20 m (66 ft)	—
QS186E (940 nm Infrared)			—
QS18VN6R			NPN
QS18VP6R			PNP
QS186EB (940 nm Infrared)	Effective beam: 13 mm (0.5 inch)	3 m (10 ft)	—
QS18VN6RB			NPN
QS18VP6RB			PNP

Model	Polarized Retroreflective Mode	Range	Output
QS18VN6LP	630 nm Visible red	3.5 m (12 ft)	NPN
QS18VP6LP			PNP

Model	Retroreflective Mode	Range	Output
QS18VN6LV	628 nm Visible red	6.5 m (21 ft)	NPN
QS18VP6LV			PNP

Model	Convergent Mode	Range	Output
QS18VN6CV15	630 nm Visible red	16 mm (0.63 in)	NPN
QS18VP6CV15			PNP

Continued on page 4

Continued from page 3

Model	Convergent Mode	Range	Output
QS18VN6CV45		43 mm (1.7 in)	NPN
QS18VP6CV45			PNP

Model	Diffuse Mode	Range	Output
QS18VN6D	940 nm Infrared	450 mm (18 in)	NPN
QS18VP6D			PNP
QS18VN6DL		600 mm (24 in)	NPN
QS18VP6DL			PNP
QS18VN6DVS	630 nm Visible red	250 mm (10 in)	NPN
QS18VP6DVS			PNP
QS18VN6DB (Wide)	Infrared	450 mm (18 in)	NPN
QS18VP6DB (Wide)			PNP

Model	Divergent Mode	Range	Output
QS18VN6W	940 nm Infrared	100 mm (4 in)	NPN
QS18VP6W			PNP

Model	Fixed Field Mode	Range	Output
QS18VN6FF50	630 nm Visible red	50 mm (2 in)	NPN
QS18VP6FF50			PNP
QS18VN6FF100		100 mm (4 in)	NPN
QS18VP6FF100			PNP
QS18VP6FF125		125 mm (5 in)	PNP
QS18VN6FF150		150 mm (6 in)	NPN
QS18VP6FF150			PNP

Model	Plastic Fiber Optic Mode	Range	Output
QS18VN6FP	660 nm Visible Red	Range varies by sensing mode and fiber optics used	NPN
QS18VP6FP			PNP

Model	Glass Fiber Optic Mode	Range	Output
QS18VN6F	940 nm Infrared	Range varies by sensing mode and fiber optics used	NPN
QS18VP6F			PNP

- To order the 4-pin M12 integral quick disconnect model, add the suffix "Q8" to the model number. For example, QS186EQ8.
- To order the 4-pin M8 integral quick disconnect model, add the suffix "Q7" to the model number. For example, QS186EQ7.
- To order the 150 mm (6 in) PVC cable model with a 4-pin M12 quick disconnect, add the suffix "Q5" to the model number. For example, QS186EQ5.
- To order the 150 mm (6 in) PVC cable model with a 4-pin M8 quick disconnect, add the suffix "Q" to the model number. For example, QS186EQ.
- Models with a quick disconnect require a mating cordset.

Specifications

Supply Voltage

10 V DC to 30 V DC (10% maximum ripple) at less than 25

mA, exclusive of load
Protected against reverse polarity and transient voltages

Light Source

Glass Fiber Optic, Opposed and Diffuse mode models:
Infrared, 940 nm

Plastic Fiber Optic, Retroreflective, Convergent models:
Visible red, 660 nm

Fixed-Field and DVS models: Visible red, 630 nm

Adjustments

Glass Fiber Optic, Plastic Fiber Optic, Convergent, Diffuse,
and Retroreflective mode models (only): Single-turn sensitivity
(Gain) adjustment potentiometer

Indicators

Two LED indicators on the sensor top

Green: Power on

Amber: Light sensed

Amber flashing: Marginal excess gain (1 to 1.5 times excess
gain)

Construction

ABS housing

3 mm mounting hardware included

Connections

2 m (6.5 ft) 4-wire PVC cable; 9 m (30 ft) 4-wire PVC cable; 4-
pin M8 or M12 QD; or 150 mm (6 in) cable with a 4-pin M8 or
M12 QD, depending on the model

Repeatability

Opposed Mode: 100 microseconds

DVS, DL and FF Modes: 90 microseconds

All Other Modes: 150 microseconds

Output Configuration

Solid-state complementary (SPDT): NPN or PNP (current
sinking or sourcing), depending on model

Rating: 100 mA maximum each output at 25 °C

DVS, DL and FF Modes ON-state Saturation Voltage: less
than 1.5 V at 10 mA; less than 3 V at 100 mA

All Other Modes: ON-state Saturation Voltage: less than 1 V
at 10 mA; less than 1.5 V at 100 mA

Protected against false pulse on power-up and continuous
overload or short circuit of outputs

Output Response

Opposed Mode: 750 microseconds ON; 375 microseconds
OFF

DVS, FF, and DL Modes: 850 microseconds ON/OFF

All Other Modes: 600 microseconds ON/OFF

100-millisecond delay on power-up; outputs do not conduct
during this time

Environmental

IEC IP67; NEMA 6

Operating Conditions

-20 °C to +70 °C (-4 °F to +158 °F)

95% at +50 °C maximum relative humidity (non-condensing)

Vibration and Mechanical Shock

Required Overcurrent Protection



WARNING: Electrical connections must
be made by qualified personnel in
accordance with local and national
electrical codes and regulations.

Overcurrent protection is required to be provided by end
product application per the supplied table.

Overcurrent protection may be provided with external fusing
or via Current Limiting, Class 2 Power Supply.

Supply wiring leads < 24 AWG shall not be spliced.

For additional product support, go
to www.bannerengineering.com.

Supply Wiring (AWG)	Required Overcurrent Protection (A)	Supply Wiring (AWG)	Required Overcurrent Protection (A)
20	5.0	26	1.0
22	3.0	28	0.8
24	2.0	30	0.5

Certifications



Banner Engineering BV
Park Lane, Culliganlaan 2F bus 3
1831 Diegem, BELGIUM



Turck Banner LTD Blenheim House
Blenheim Court
Wickford, Essex SS11 8YT
GREAT BRITAIN



NOTE: For performance specifications of the FF50 and FF100 models built prior to date code 17090, refer
to document p/n [63908](#).

FCC Part 15 Class A for Unintentional Radiators

This equipment has been tested and found to comply with the limits for a Class A digital device, pursuant to Part 15 of the FCC Rules. These limits are designed to provide reasonable protection against harmful interference when the equipment is operated in a commercial environment. This equipment generates, uses, and can radiate radio frequency energy and, if not installed and used in accordance with the instruction manual, may cause harmful interference to radio communications. Operation of this equipment in a residential area is likely to cause harmful interference in which case the user will be required to correct the interference at his own expense.

(Part 15.21) Any changes or modifications not expressly approved by the party responsible for compliance could void the user's authority to operate this equipment.

Industry Canada ICES-003(A)

This device complies with CAN ICES-3 (A)/NMB-3(A). Operation is subject to the following two conditions: 1) This device may not cause harmful interference; and 2) This device must accept any interference received, including interference that may cause undesired operation.

Cet appareil est conforme à la norme NMB-3(A). Le fonctionnement est soumis aux deux conditions suivantes : (1) ce dispositif ne peut pas occasionner d'interférences, et (2) il doit tolérer toute interférence, y compris celles susceptibles de provoquer un fonctionnement non souhaité du dispositif.

Dimensions

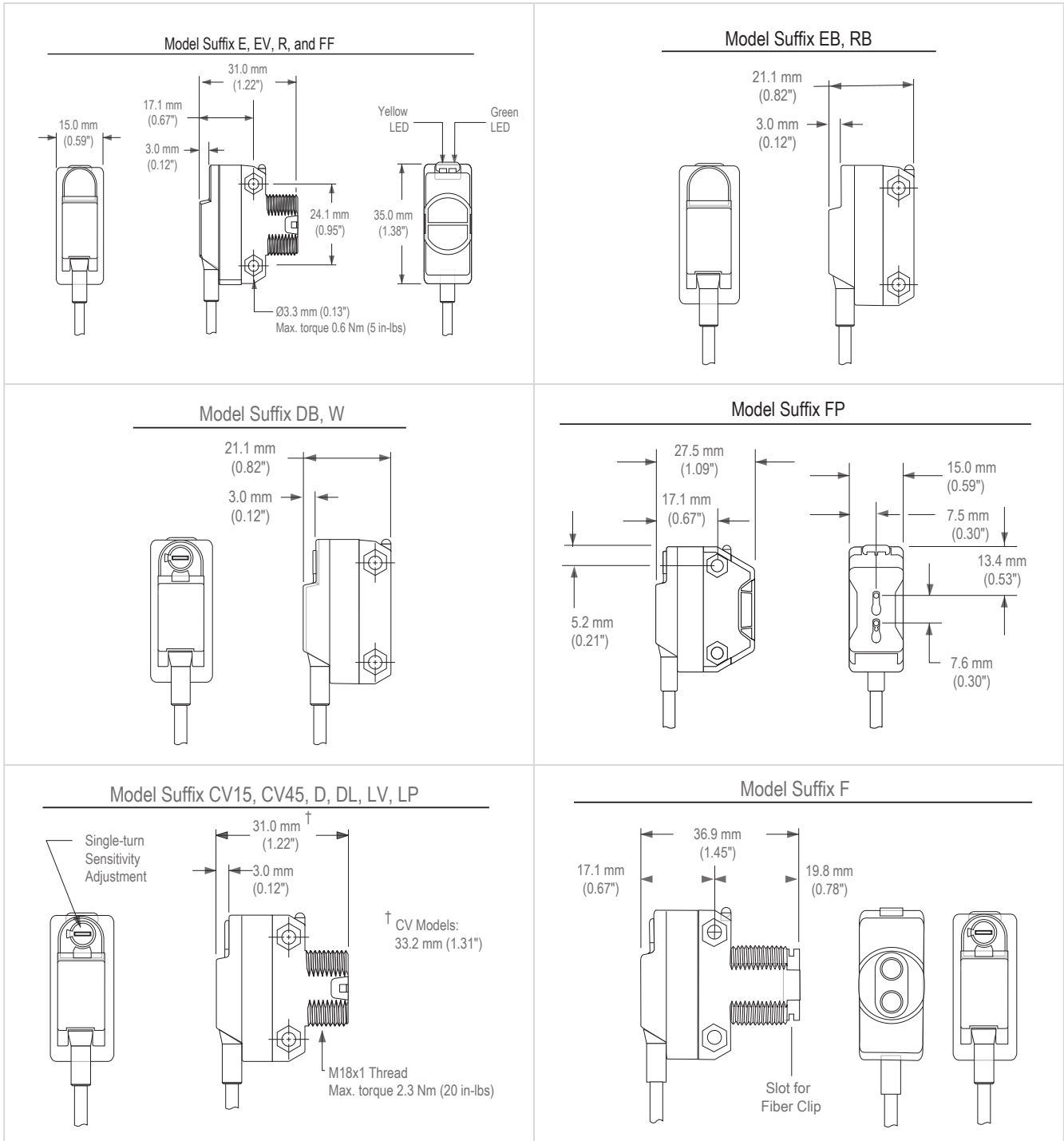

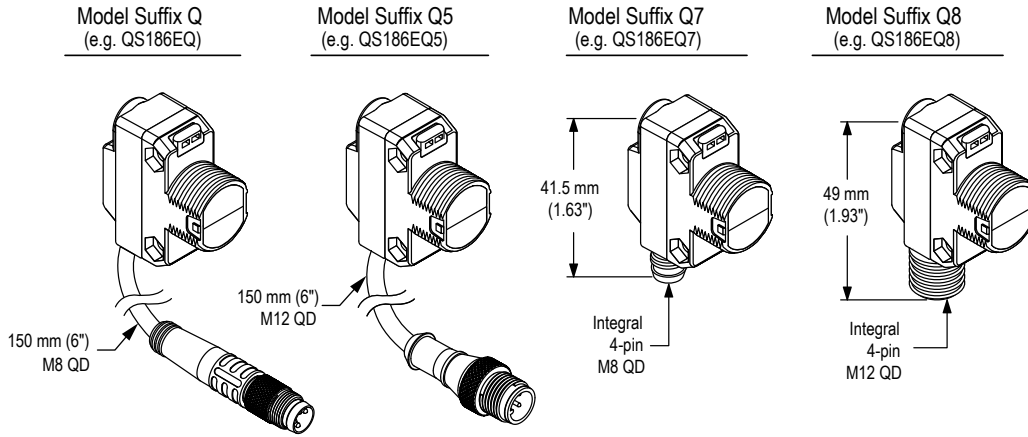

<p>M18 x 1 Jam Nut</p>	<p>M3 hardware packet contents:</p> <ul style="list-style-type: none"> • 2 - M3 x 0.5 x 20 mm stainless steel screw • 2 - M3 x 0.5 stainless steel hex nut • 2 - M3 stainless steel washer 	<p>Packing list:</p> <ul style="list-style-type: none"> • Sensor • M18 x 1 jam nut • M3 hardware packet • Quick Start Guide, p/n 63687
-------------------------------	--	---

Performance Curves

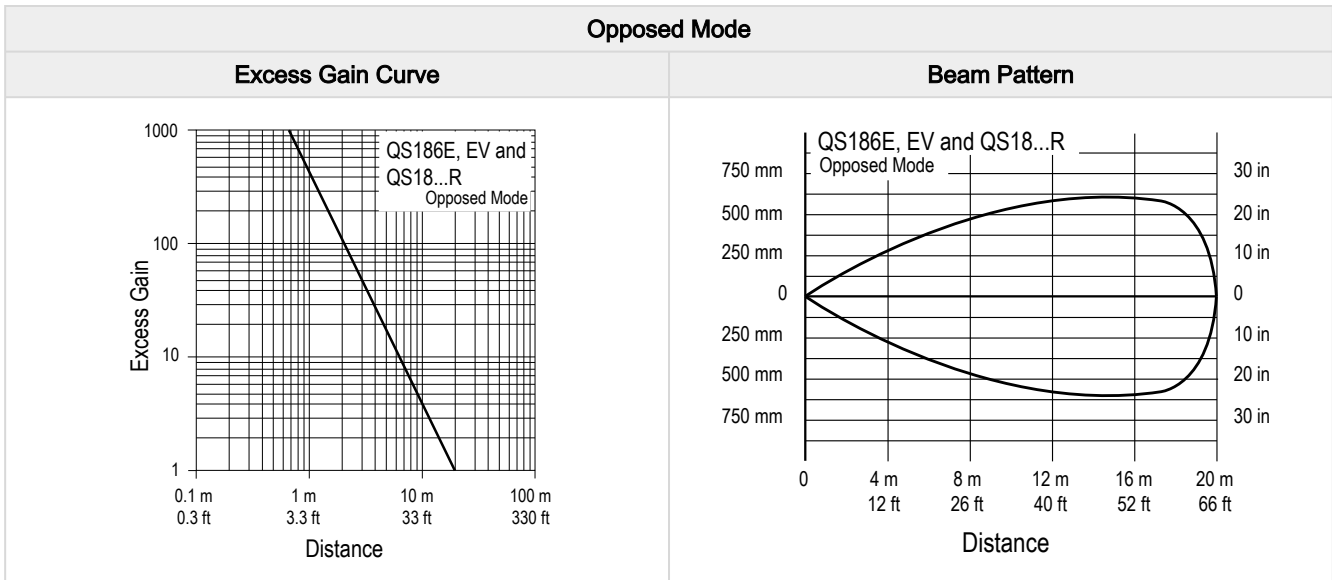

Continued on page 8

Continued from page 7

Opposed Mode

Excess Gain Curve

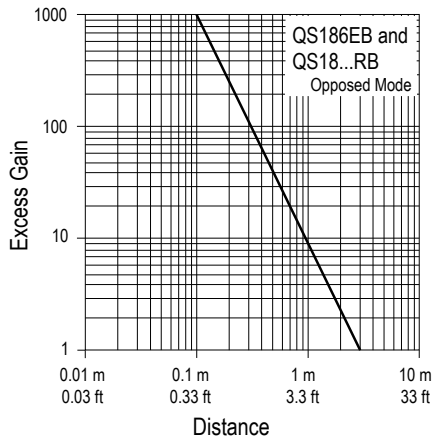

Beam Pattern

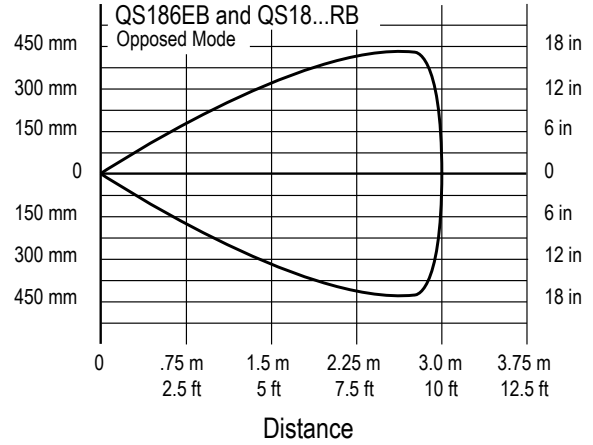

Polarized Retroreflective

Excess Gain Curve

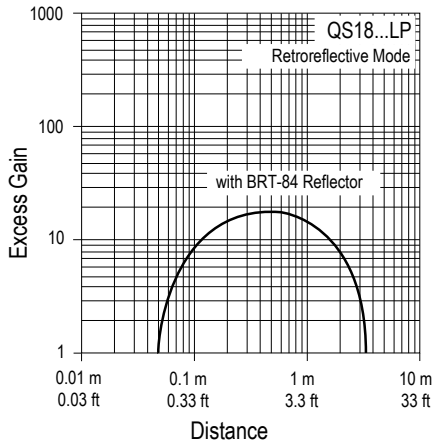

Beam Pattern

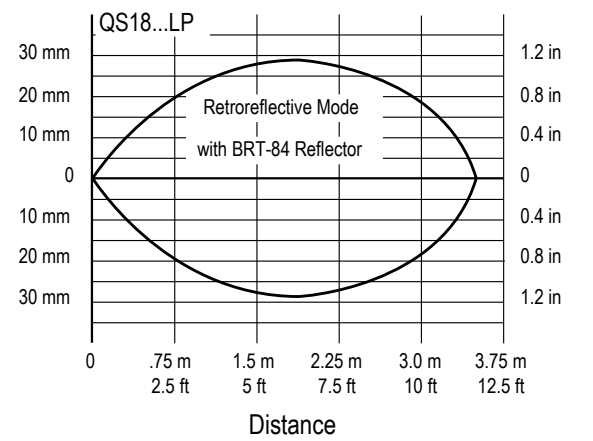

Retroreflective

Excess Gain Curve

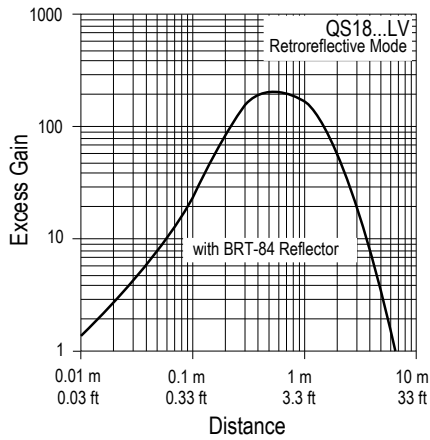

Beam Pattern

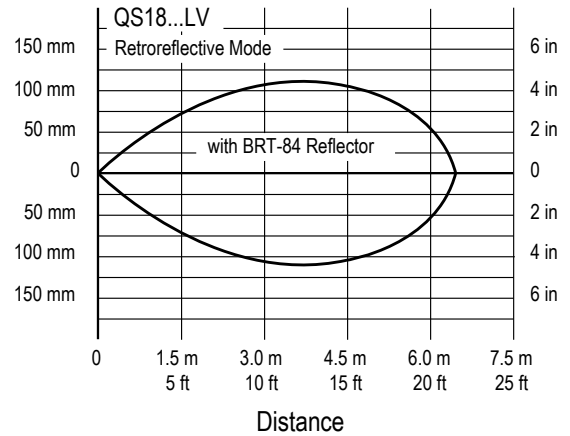

Convergent (Performance is based on a 90% reflectance white test card.)

Excess Gain Curve

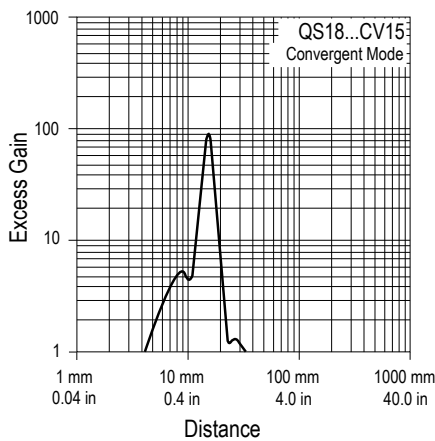

Beam Pattern

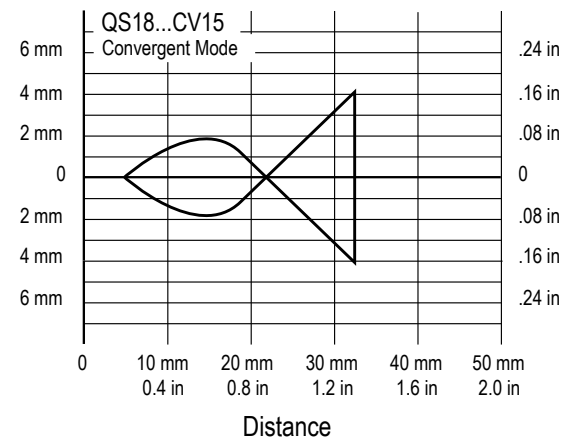

Excess Gain Curve

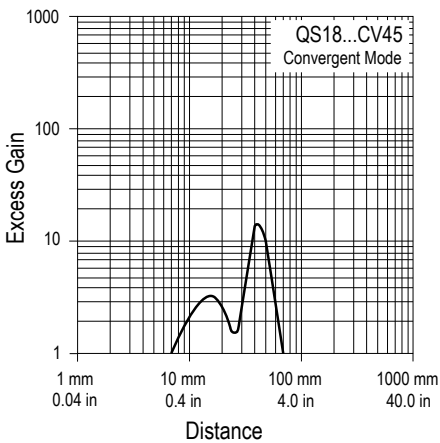

Beam Pattern

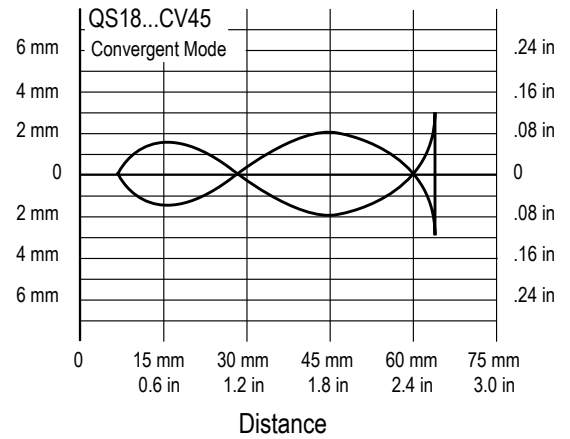

Diffuse (Performance is based on a 90% reflectance white test card.)

Excess Gain Curve

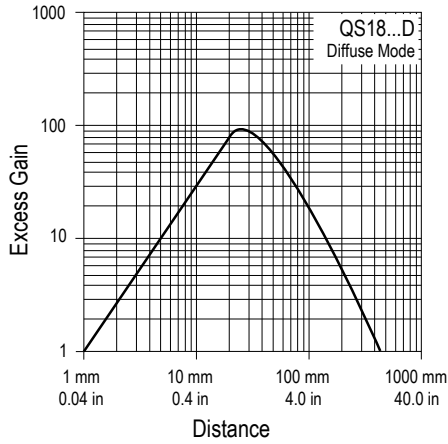

Beam Pattern

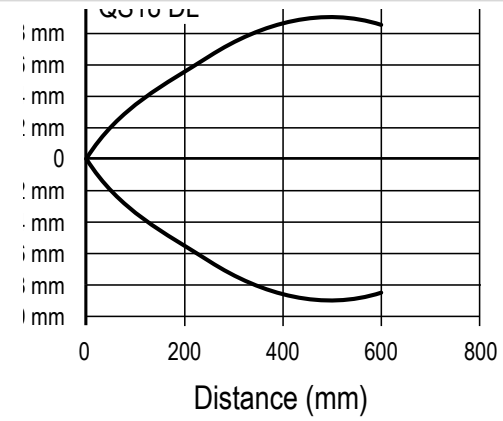
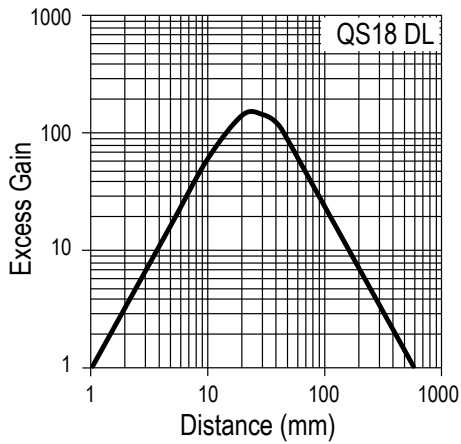
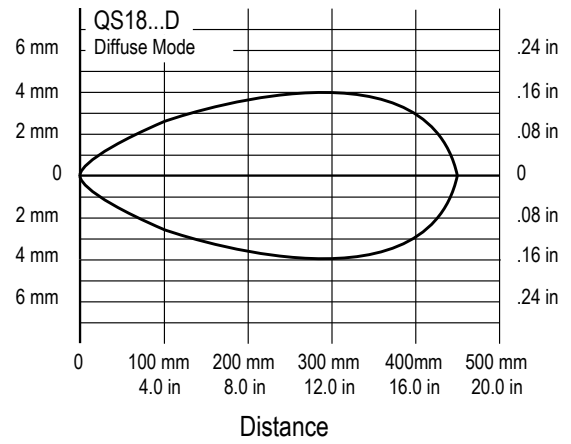

Diffuse (Performance is based on a 90% reflectance white test card.)

Excess Gain Curve

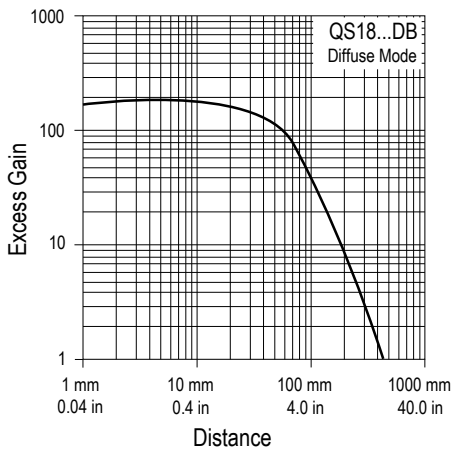

Beam Pattern

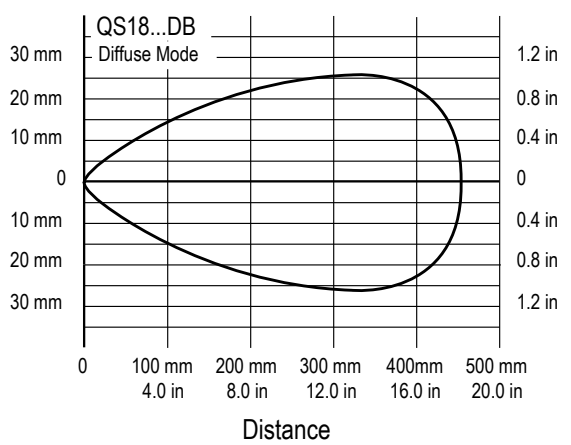

Continued on page 11

Continued from page 10

Diffuse (Performance is based on a 90% reflectance white test card.)

Excess Gain Curve

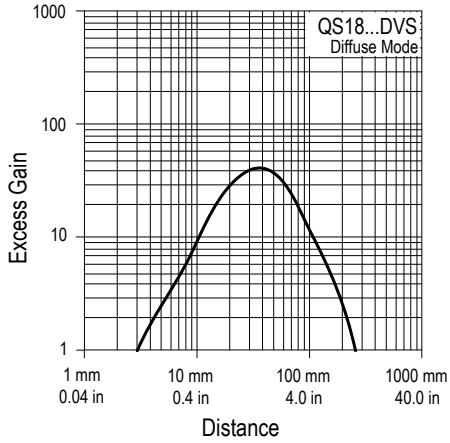

Beam Pattern

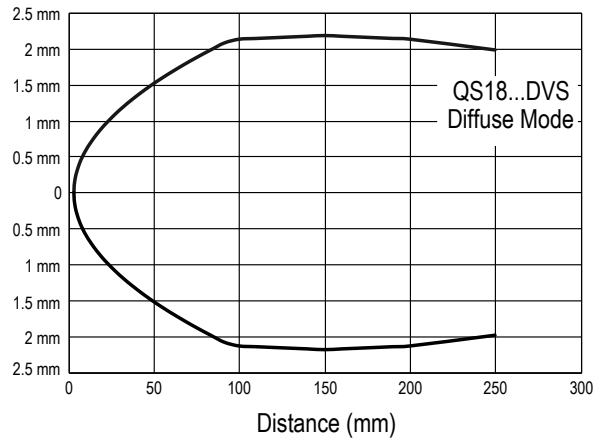

Divergent (Performance is based on a 90% reflectance white test card.)

Excess Gain Curve

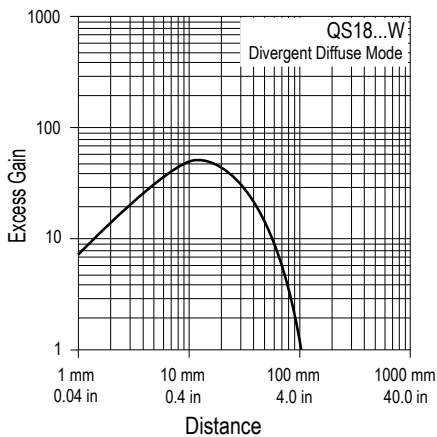

Beam Pattern

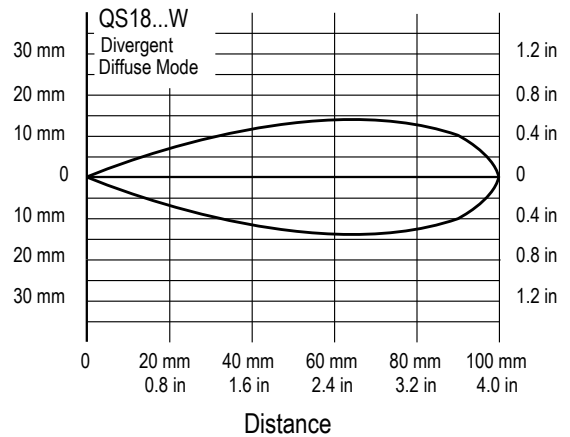

Fixed Field

Excess Gain Curve (50 mm)

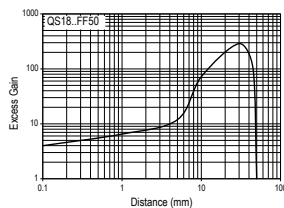

Excess Gain Curve (100 mm)

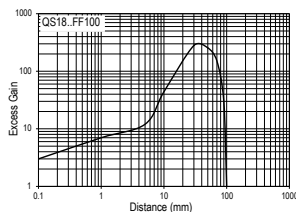

Excess Gain Curve (150 mm)

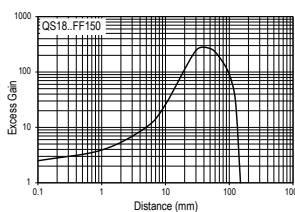

Spot Sizes

- 50 mm Models:
At 25 mm: 8 × 5.5 mm
At 50 mm: 6 × 5 mm
- 100 mm Models
At 50 mm: 6 × 4 mm
At 100 mm: 3 × 3 mm
- 150 mm Models
At 75 mm: 5 × 3.5 mm
At 150 mm: 6 × 6 mm

Opposed - Plastic Fiber

Excess Gain Curve

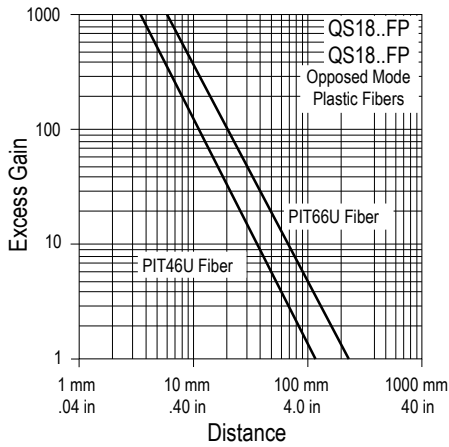

Beam Pattern

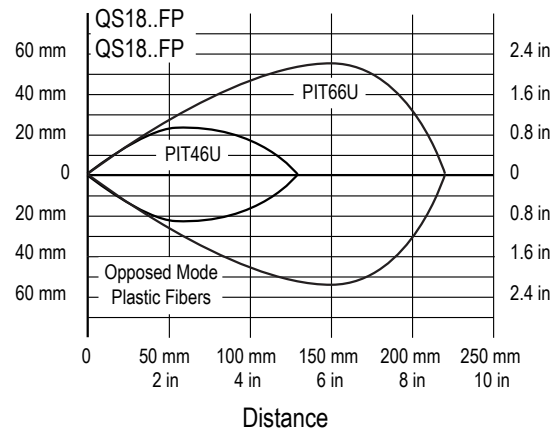

Bifurcated - Plastic Fiber (Performance is based on a 90% reflectance white test card.)

Excess Gain Curve

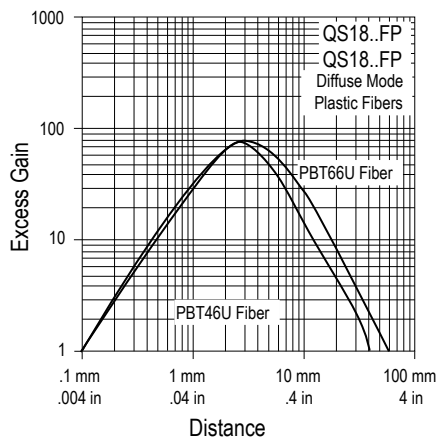

Beam Pattern

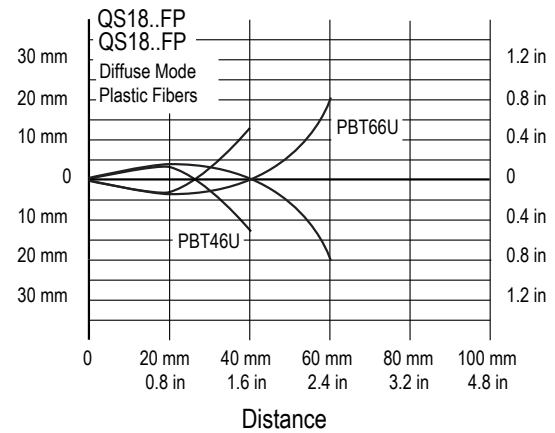

Opposed - Glass Fiber (Performance is based on a 90% reflectance white test card.)

Excess Gain Curve

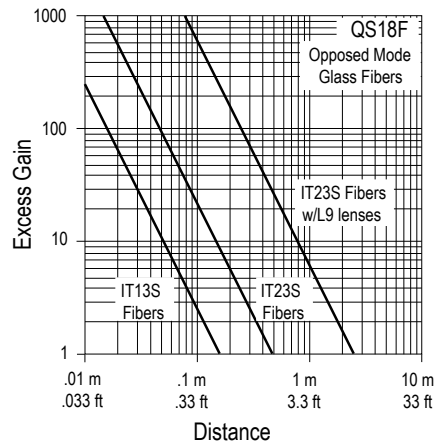

Beam Pattern

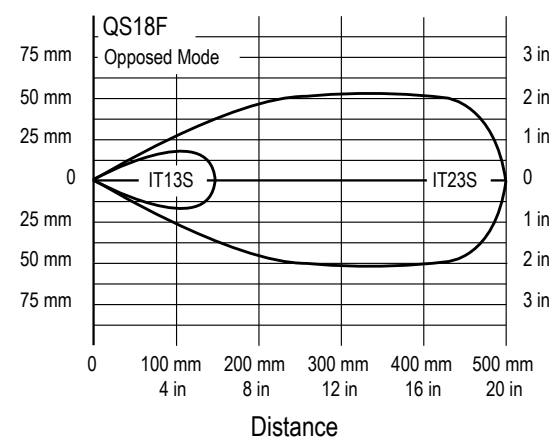

Bifurcated - Glass Fiber (Performance is based on a 90% reflectance white test card.)

Excess Gain Curve

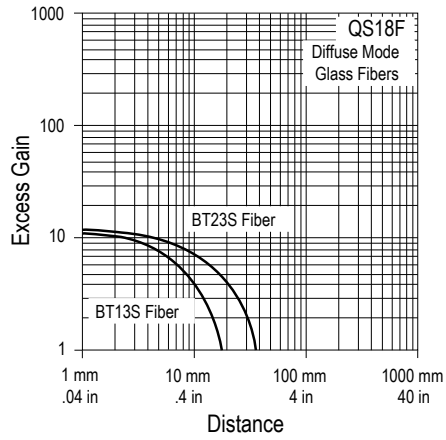

Beam Pattern

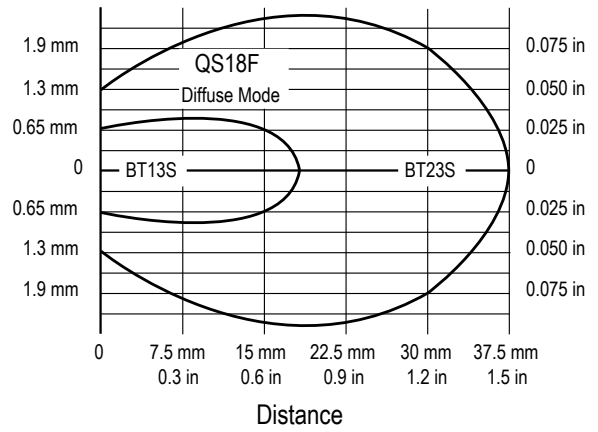

Chapter Contents

Wiring Diagrams 14
 Installing Fibers 14
 Mount the Device 15

Chapter 2 Installation Instructions

Wiring Diagrams

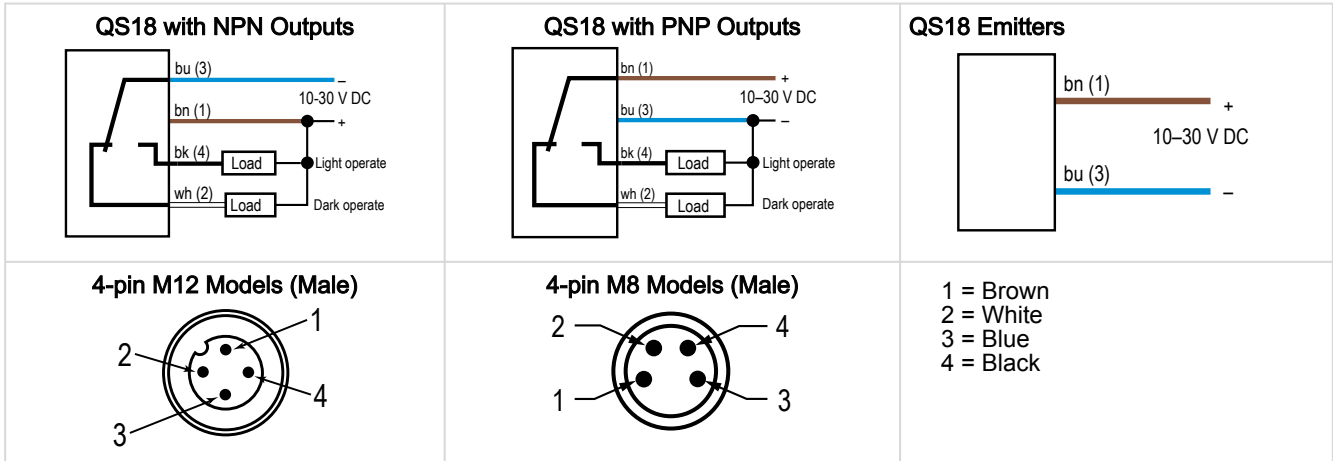

In dark operate (DO) mode, the output is ON when the target returns less light to the sensor than the configured target and OFF when the sensor detects more light than the configured/taught target.

In light operate (LO) mode, the output is ON when the target returns the same or more light to the sensor and OFF when the sensor detects less light than the configured/taught target.

In **opposed and retroreflective sensing modes**, light operate is active when the beam is unblocked and dark operate is active when the beam is blocked.

In **diffuse and fixed field sensing modes**, light operate is active when the target is present and dark operate is active when the target is absent.

Installing Fibers

Cutting Unterminated Plastic Fibers

Unterminated plastic fibers are designed to be cut by the user to the length required for the application.

To facilitate cutting, a Banner model **PFC-1** cutting device is supplied with the fiber. Cut the fiber as follows:

PFC-1 Cutting Device

Use small ports for fiber sizes:

- 0.25 mm (0.01 inches)
- 0.5 mm (0.02 inches)

Use large ports for fiber sizes:

- 0.75 mm (0.03 inches)
- 1.0 mm (0.04 inches)
- 1.5 mm (0.06 inches)

1. Locate the control end of the fiber (the unfinished end).

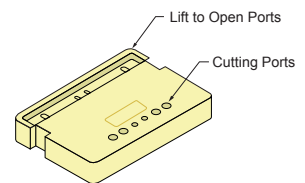

- Determine the length of fiber required for the application. If using a bifurcated fiber, separate the two halves of the fiber at least 51 mm (2 inches) beyond the fiber-cutting location.
- Lift the top (blade) of the cutter to open the cutting ports.
- Insert one of the control ends through one of the cutting ports on the cutter so that the excess fiber protrudes from the back of the cutter.
- Double-check the fiber length, and close the cutter until the fiber is cut.
- Using a different cutting port, cut the second control end to the required length.

NOTE: To ensure a clean cut each time, do not use a cutting port more than once.

- Gently wipe the cut ends of the fiber with a clean, dry cloth to remove any contamination. Do not use solvents or abrasives on any exposed optical fiber.

Install the Plastic Fibers

Follow these steps to install the plastic fibers.

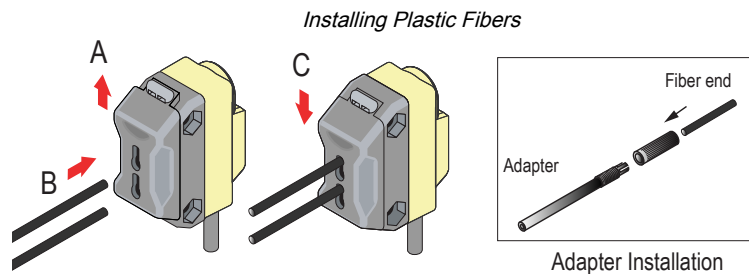

- Slide the fiber gripper up to unlock it (A).
- If using 0.25 mm or 0.5 mm core fibers, slide the plastic fiber adapters onto the fibers, flush with the fiber ends.
- Carefully insert the prepared plastic fiber ends into the ports (B) as far as possible without applying extra force.
- Slide the fiber gripper down to lock the fibers in place (C).

Install the Glass Fibers

Follow these steps to install the glass fibers.

Installing the glass fibers in a QS18 sensor

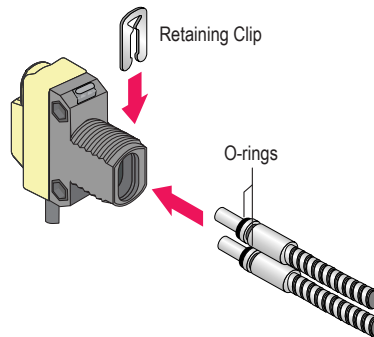

- Slide the supplied o-ring on the sensor end of the fibers, as shown.
- Press the fiber ends firmly into the ports located on the front of the sensor.
- Slide the supplied u-shaped retaining clip into the slot in the sensor's barrel until the clip snaps into place.

Mount the Device

- If a bracket is needed, mount the device onto the bracket.

2. Mount the device (or the device and the bracket) to the machine or equipment at the desired location. Do not tighten the mounting screws at this time.
3. Check the device alignment.
4. Tighten the mounting screws to secure the device (or the device and the bracket) in the aligned position.

Chapter Contents

Sensor Sensitivity Adjustment 17

Chapter 3 Operating Instructions

Sensor Sensitivity Adjustment

After the sensor and retroreflector have been properly installed, the sensor is ready to be adjusted to ensure detection of the desired object. Sensor sensitivity is adjusted with the single turn adjuster.

Chapter Contents

Cordsets 18
 Sensor Status Indicators 19
 QS18 Brackets 19
 Retroreflective Targets 19
 Plastic and Glass Fiber Optics 20

Chapter 4 QS18 Accessories

Cordsets

4-pin Single-Ended M12 Female Cordsets				
Model	Length	Dimensions (mm)	Pinout (Female)	
BC-M12F4-22-1	1 m (3.28 ft)			<p>1 = Brown 2 = White 3 = Blue 4 = Black 5 = Unused</p>
BC-M12F4-22-2	2 m (6.56 ft)			
BC-M12F4-22-5	5 m (16.4 ft)			
BC-M12F4-22-8	8 m (26.25 ft)			
BC-M12F4-22-10	10 m (30.81 ft)			
BC-M12F4-22-15	15 m (49.2 ft)			
BC-M12F4-22-20	20 m (65.61 ft)			
BC-M12F4-22-25	25 m (82.02 ft)			
BC-M12F4-22-30	30 m (98.42 ft)			

4-pin Single-Ended M12 Female Right-Angle Cordsets				
Model	Length	Dimensions (mm)	Pinout (Female)	
BC-M12F4A-22-1	1 m (3.28 ft)			<p>1 = Brown 2 = White 3 = Blue 4 = Black 5 = Unused</p>
BC-M12F4A-22-2	2 m (6.56 ft)			
BC-M12F4A-22-5	5 m (16.4 ft)			
BC-M12F4A-22-8	8 m (26.25 ft)			
BC-M12F4A-22-10	10 m (30.81 ft)			
BC-M12F4A-22-15	15 m (49.2 ft)			

4-Pin Single-Ended Snap-on M8 Female Cordsets				
Model	Length	Style	Dimensions	Pinout (Female)
PKG4-2	2.03 m (6.66 ft)	Straight		<p>1 = Brown 2 = White 3 = Blue 4 = Black</p>

Continued on page 19

Continued from page 18

4-Pin Single-Ended Snap-on M8 Female Cordsets					
Model	Length	Style	Dimensions	Pinout (Female)	
PKW4Z-2	2 m (6.56 ft)	Right-Angle			

Sensor Status Indicators

S15L Series In-Line Sensor Status Indicator						
Model	Input Type	LED Color	Dimensions	Female	Male	Wiring
S15LGYPQ	PNP	Power ON = Green Input Active = Yellow				1 = Brown, 10 to 30 V DC 2 = White 3 = Blue, DC common 4 = Black, Sensor Input
S15LGYNQ	NPN					

QS18 Brackets

<p>SMB18A</p> <ul style="list-style-type: none"> Right-angle mounting bracket with a curved slot for versatile orientation 12-ga. stainless steel 18 mm sensor mounting hole Clearance for M4 (#8) hardware <p>Hole center spacing: A to B = 24.2 Hole size: A = \varnothing 4.6, B = 17.0 x 4.6, C = \varnothing 18.5</p>	
<p>SMB312S</p> <ul style="list-style-type: none"> Stainless steel 2-axis, side-mount bracket <p>A = 4.3 x 7.5, B = diam. 3, C = 3 x 15.3</p>	

All measurements are in millimeters.

Retroreflective Targets

Go to www.bannerengineering.com for complete information.

NOTE: Polarized sensors require corner cube-type retroreflective targets only.

Plastic and Glass Fiber Optics

Go to www.bannerengineering.com for a list of plastic and glass fiber optic cables.

Chapter Contents

Clean Sensor with Compressed Air Then Isopropyl Alcohol 21
Repairs 21
Contact Us 21
Banner Engineering Corp Limited Warranty 21

Chapter 5 Product Support and Maintenance

Clean Sensor with Compressed Air Then Isopropyl Alcohol

Handle the sensor with care during installation and operation. Sensor windows soiled by fingerprints, dust, water, oil, etc. create stray light that may degrade the peak performance of the sensor.

Blow dust from the sensor using filtered, compressed air. If the sensor is still dirty, gently wipe the sensor with a dry optical cloth. If the dry optical cloth does not remove all residue, use 70% isopropyl alcohol on a clean optical cloth, then dry with a clean dry optical cloth and blow with filtered, compressed air. Do not use any other chemicals for cleaning.

Repairs

Contact Banner Engineering for troubleshooting of this device. **Do not attempt any repairs to this Banner device; it contains no field-replaceable parts or components.** If the device, device part, or device component is determined to be defective by a Banner Applications Engineer, they will advise you of Banner's RMA (Return Merchandise Authorization) procedure.

IMPORTANT: If instructed to return the device, pack it with care. Damage that occurs in return shipping is not covered by warranty.

Contact Us

Banner Engineering Corp. | 9714 Tenth Avenue North | Plymouth, MN 55441, USA | Phone: + 1 888 373 6767

For worldwide locations and local representatives, visit www.bannerengineering.com.

Banner Engineering Corp Limited Warranty

Banner Engineering Corp. warrants its products to be free from defects in material and workmanship for one year following the date of shipment. Banner Engineering Corp. will repair or replace, free of charge, any product of its manufacture which, at the time it is returned to the factory, is found to have been defective during the warranty period. This warranty does not cover damage or liability for misuse, abuse, or the improper application or installation of the Banner product.

THIS LIMITED WARRANTY IS EXCLUSIVE AND IN LIEU OF ALL OTHER WARRANTIES WHETHER EXPRESS OR IMPLIED (INCLUDING, WITHOUT LIMITATION, ANY WARRANTY OF MERCHANTABILITY OR FITNESS FOR A PARTICULAR PURPOSE), AND WHETHER ARISING UNDER COURSE OF PERFORMANCE, COURSE OF DEALING OR TRADE USAGE.

This Warranty is exclusive and limited to repair or, at the discretion of Banner Engineering Corp., replacement. **IN NO EVENT SHALL BANNER ENGINEERING CORP. BE LIABLE TO BUYER OR ANY OTHER PERSON OR ENTITY FOR ANY EXTRA COSTS, EXPENSES, LOSSES, LOSS OF PROFITS, OR ANY INCIDENTAL, CONSEQUENTIAL OR SPECIAL DAMAGES RESULTING FROM ANY PRODUCT DEFECT OR FROM THE USE OR INABILITY TO USE THE PRODUCT, WHETHER ARISING IN CONTRACT OR WARRANTY, STATUTE, TORT, STRICT LIABILITY, NEGLIGENCE, OR OTHERWISE.**

Banner Engineering Corp. reserves the right to change, modify or improve the design of the product without assuming any obligations or liabilities relating to any product previously manufactured by Banner Engineering Corp. Any misuse, abuse, or improper application or installation of this product or use of the product for personal protection applications when the product is identified as not intended for such purposes will void the product warranty. Any modifications to this product without prior express approval by Banner Engineering Corp will void the product warranties. All specifications published in this document are subject to change; Banner reserves the right to modify product specifications or update documentation at any time. Specifications and product information in English supersede that which is provided in any other language. For the most recent version of any documentation, refer to: www.bannerengineering.com.

For patent information, see www.bannerengineering.com/patents.

 [LinkedIn](#)

 [X \(formerly Twitter\)](#)

 [Facebook](#)

