

**Inductive sensor**  
**With increased switching distance**  
**BI2-EG08-AN6X-V1131**

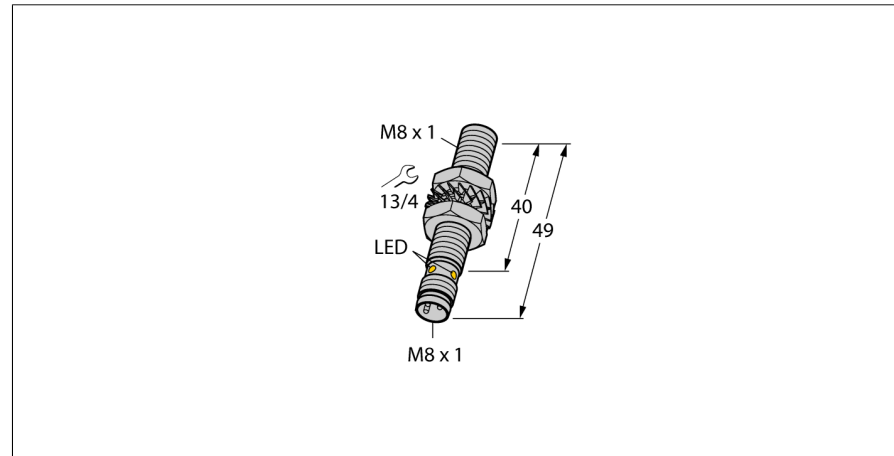

- Threaded barrel, M8 x 1
- Stainless steel, 1.4427 SO
- Large sensing range
- DC 3-wire, 10...30 VDC
- NO contact, NPN output
- M8 x 1 male connector

**Wiring Diagram**

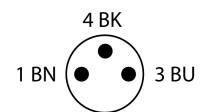
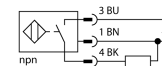

<b>Type designation</b>	BI2-EG08-AN6X-V1131
Ident no.	4602150
<b>Rated switching distance Sn</b>	2 mm
Mounting conditions	Flush
Secured operating distance	≤ (0,81 x Sn) mm
Correction factors	St37 = 1; Al = 0.3; stainless steel = 0.7; Ms = 0.4
Repeat accuracy	≤ 2 % of full scale
Temperature drift	≤ ± 10 %
Hysteresis	3...15 %
Ambient temperature	-25...+70 °C
<b>Operating voltage</b>	10...30 VDC
Residual ripple	≤ 10 % U <sub>ss</sub>
DC rated operational current	≤ 150 mA
No-load current I <sub>0</sub>	≤ 15 mA
Residual current	≤ 0.1 mA
Isolation test voltage	≤ 0.5 kV
Short-circuit protection	yes/ Cyclic
Voltage drop at I <sub>0</sub>	≤ 1.8 V
Wire breakage/Reverse polarity protection	yes/ Complete
Output function	3-wire, NO contact, NPN
Switching frequency	3 kHz
<b>Design</b>	Threaded barrel, M8 x 1
Dimensions	49 mm
Housing material	Stainless steel, 1.4427 SO
Active area material	Plastic, PA12-GF30
Max. tightening torque housing nut	5 Nm
Electrical connection	Connectors, M8 x 1
Vibration resistance	55 Hz (1 mm)
Shock resistance	30 g (11 ms)
Protection class	IP67
MTTF	2283 years acc. to SN 29500 (Ed. 99) 40 °C
Packaging unit	1
<b>Switching state</b>	LED, Yellow

**Functional principle**

Inductive sensors detect metal objects contactless and wear-free. For this, they use a high-frequency electromagnetic AC field that interacts with the target. Inductive sensors generate this field via an RLC circuit with a ferrite coil.

**Inductive sensor**  
**With increased switching distance**  
**BI2-EG08-AN6X-V1131**

Distance D	2 x B
Distance W	3 x Sn
Distance T	3 x B
Distance S	1.5 x B
Distance G	6 x Sn
<hr/>	
Diameter active area B	Ø 8 mm



**Inductive sensor  
With increased switching distance  
BI2-EG08-AN6X-V1131**

**Accessories**

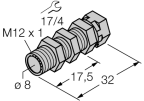
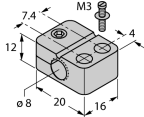
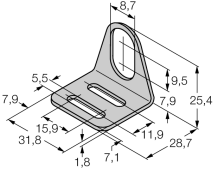
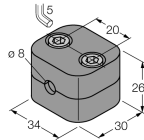
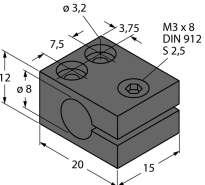
Type code	Ident no.	Description	
QM-08	6945100	Quick-mount bracket with dead-stop, chrome-plated brass, male thread M12 x 1. Note: The switching distance of proximity switches may be reduced through the use of quick-mount brackets.	
BST-08B	6947210	Fixing clamp for threaded barrel devices, with dead-stop; material: PA6	
MW-08	6945008	Mounting bracket for threaded barrel devices; material: Stainless steel A2 1.4301 (AISI 304)	
BSS-08	6901322	Mounting bracket for smooth and threaded barrel devices; material: Polypropylene	
MBS80	69479	Mounting bracket for threaded barrel devices; material mounting block: Anodized aluminium	

**Inductive sensor  
With increased switching distance  
BI2-EG08-AN6X-V1131**

**Wiring accessories**

Type code	Ident no.	Description	
PKG3M-2/TEL	6625385	Connection cable, female M8, straight, 3-pin, stainless steel coupling nut, cable length: 2 m, sheath material: PVC, black; cULus approval; other cable lengths and qualities available, see <a href="http://www.turck.com">www.turck.com</a>	