

Operating instructions

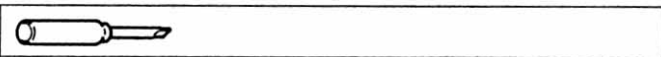

SYN 168 h
SUL 188 h
MEM 198 h
TM 178 h

theben

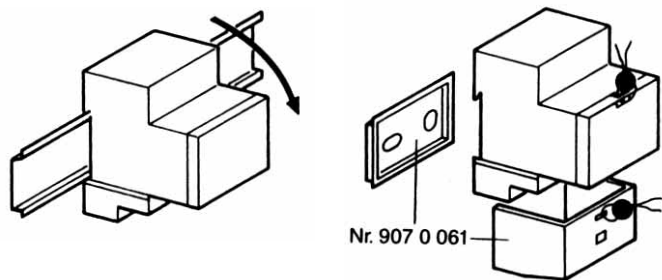

GB MOUNTING INSTRUCTIONS

Safety information: Electrical devices should only be connected and mounted by an electrical specialist. Manipulations and modifications on the switch will result in loss of warranty. The national specifications and applicable safety regulations must be observed.

Synchron
 230 V / 50 Hz
 Quartz * R = 3d (72h) NiMh
 230 V / 45 - 60 Hz

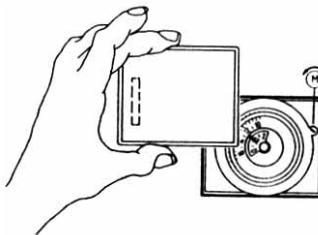
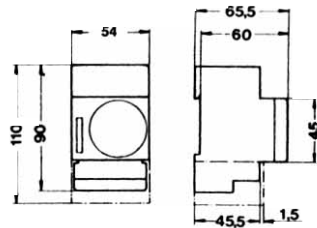
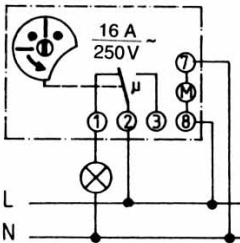

* A la mise sous tension, le mouvement à quartz démarre de lui-même au bout de quelques minutes. La réserve de marche pleine sera

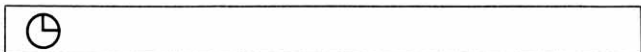

24 h Programm

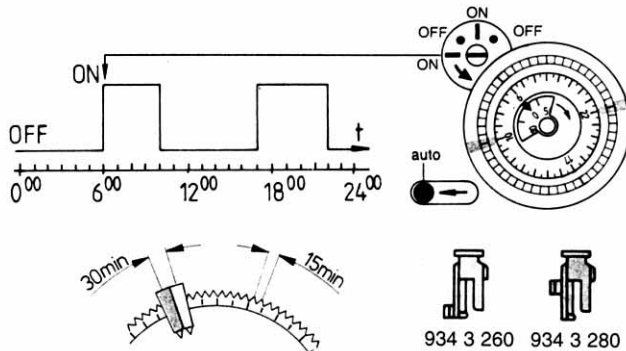
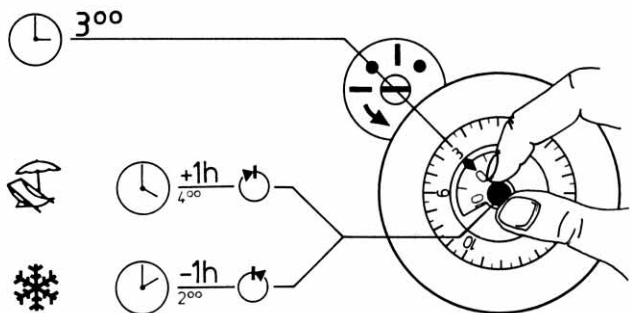

7 d Programm

60' Programm

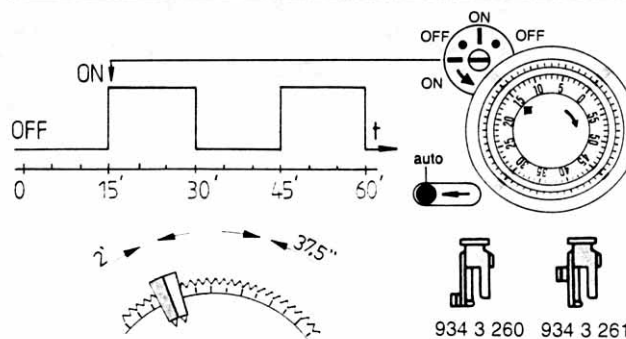
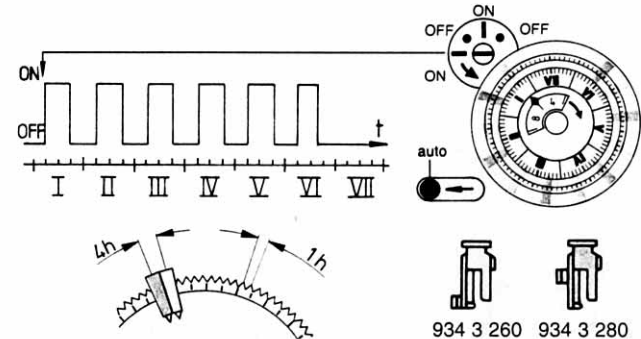

(Programm Order Nr. 934 3 262)

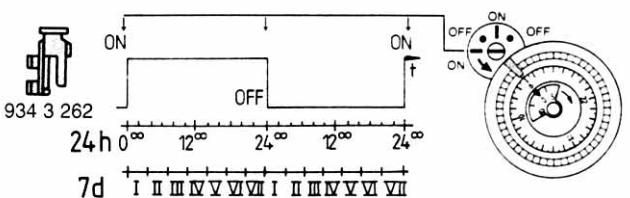

Programm

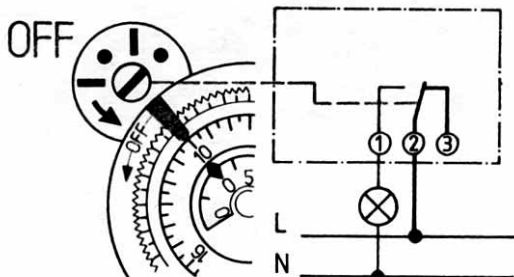
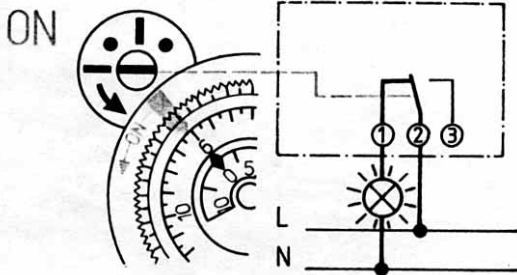

permanent ON / OFF

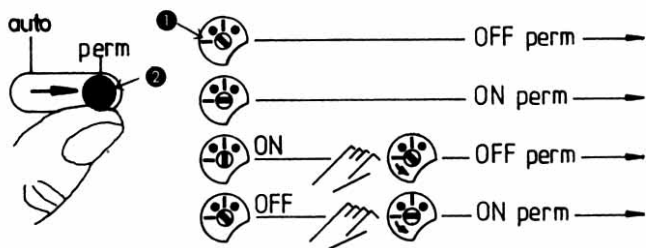

GB Permanent Control ON/OFF
Set the hand lever ② to «perm» = permanent control; turning the control axis ① in direction of arrow, the required permanent control ON or OFF can now be adjusted. Turning the hand lever to «Auto» = Automatic Control, the permanent control is terminated. The actual switch position is maintained until the next counteracting command of the automatic program sequence is triggered. An immediate correction can be carried out by means of the manual control (override control).

manual

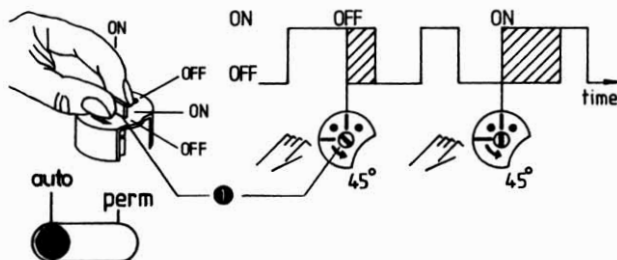

GB Manual Control ON/OFF (Override Control)
Turn the control axis ① in direction of arrow by one notch; ON = \downarrow / \uparrow or OFF = \swarrow / \searrow . The manual control is automatically annulled by the following counteracting command of the automatic program sequence.

EMV / CEM / EMC / ETY

GB The time switches are in accordance with the European directives 73/23/EEC (Low-Voltage Directive) and 89/336/EEC (EMC-Directive). If the time switches are used together with other devices in an installation, take care that the complete installation does not cause a radio interference.

D Theben AG
Postfach 56, D-72394 Haigerloch
Telefon (0 74 74) 692-0, Telefax: (0 74 74) 692 150
Kundendienst
Telefon (0 74 74) 692-177, Telefax (0 74 74) 692-207 www.theben.de

GB TIMEGUARD LTD,
Victory Park, 400 Edgware Road
London NW2 6ND
Tel. 0181/4508944;
Fax: 0181/4525143

AUS PETER WARBURTON PTY. LIMITED,
64 Britannia Road, Castle Hill
NSW 2154, Australia,
Tel.: (02) 9899 2908,
Fax: (02) 9899 4486