

**Ultrasonic sensor
diffuse mode sensor
QS18UPAE**

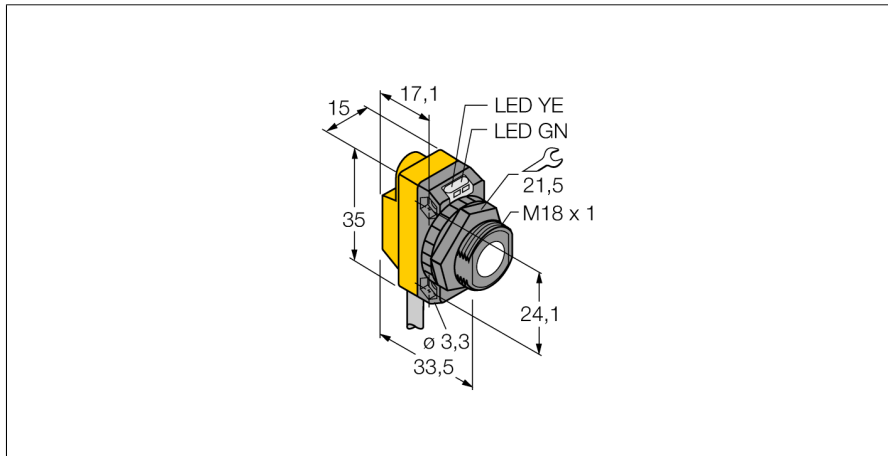

- Blind zone: 5 cm
- Range: 50 cm
- Operating voltage 12...30 VDC
- Compact design
- Cable, 2 m
- Switching range adjustable via teach-connection
- Adjustable to retroreflective mode

Wiring Diagram

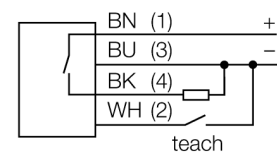

Functional principle

Ultrasonic sensors detect a multitude of objects contactless and wear-free with ultrasonic waves. Regardless of whether the object is transparent or opaque, metallic or non-metallic, liquid, solid or powdery. Even environmental conditions such as spray, dust or rain hardly affect their function.

Type designation	QS18UPAE
Ident no.	3073165
Operating mode	Diffuse mode ultrasonic sensor
Range	5...50cm
Ultrasound frequency	300 kHz
Repeatability	≥ ± 0.7 mm
Edge lengths of the nominal actuator	50 mm
Operating voltage	12... 30VDC
No-load current I ₀	≤ 25 mA
Output function	NO contact, PNP
Switching frequency	33 Hz
Hysteresis	≤ 1.4 mm
Short-circuit protection	yes
Reverse polarity protection	complete
Wire breakage protection	yes
Construction	rectangular, QS18U
Radiation direction	straight
Dimensions	33.5 x 15 x 35 mm
Housing material	Plastic, ABS
Transducer material	Plastic, Epoxyd resin and PU foam
Electrical connection	cable, 2
Protection class	IP68
Ambient temperature	-20...+60 °C
Approvals	CE
Power-on indication	LED
Switching state	LED
Object detected	LED

**Ultrasonic sensor
diffuse mode sensor
QS18UPAE**

TURCK

Industrial
Automation

Accessories

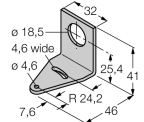
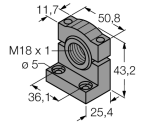
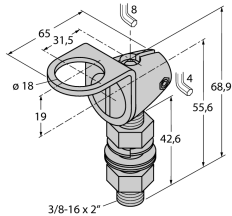
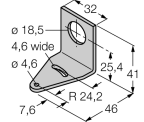
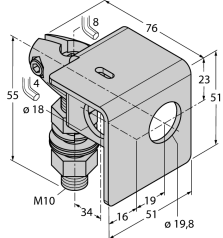
Type code	Ident no.	Description	
SMB18A	3470200	Mounting bracket, stainless steel, for sensors with 18 mm thread	
SMB18SF	3052519	Mounting bracket, PBT black, for sensors with 18 mm thread, rotatable	
SMB18FA	3074004	Mounting bracket, material VA 1.4401, for 18 mm thread, 3/8" - 16 x 2" thread	
SMB18FM	3079421	mounting bracket, black, M22 x1.5 mm, male thread, female thread M18 x 1, for sensors with 18 mm thread	
SMB18UR	3052517	Mounting bracket, for wall mounting, stainless steel 300, 2-piece, rotatable, 18 mm bore hole, screw set included	
SMB18A	3033200	Mounting bracket, rectangular, stainless steel, for sensors with 18 mm thread	
SMB18AFAM10	3012558	Mounting bracket, material VA 1.4401, for M10 x 1.5 thread, thread length 18 mm	

Ultrasonic sensor
diffuse mode sensor
QS18UPAE

TURCK

Industrial
Automation

Function accessories

Type code	Ident no.	Description	
UWG18-6.4	3076952	Ultrasonic focussing-adapter for QS18U and S18U, internal diameter 6.4 mm	
UWG18-5.0	3077342	Ultrasonic focussing-adapter for QS18U and S18U, internal diameter 5.0 mm	