

Timers

Delay on Operate

Types HAA08, HAA14

CARLO GAVAZZI



- Time range 0.1 s to 100 h
- Dip-switch selection of time range
- Knob adjustable time setting
- Dip-switch selection of operating mode (4 functions):
 - Op - delay on operate
 - R - symmetrical recycler ON first
 - Rb - symmetrical recycler OFF first
 - In - interval
- Automatic start
- Repeatability: $\pm 0.3\%$ on full scale
- Output: 8 A DPDT relay (HAA08), 5 A 4PDT relay (HAA14)
- 21.5 x 28 mm housing
- 8-pin, 14-pin blade socket for HAA08, HAA14 respectively
- LED indication for relay status and power supply ON

Product Description

Delay on operate timer with 4 functions and selectable time ranges from 0.1 seconds to 100 hours. Housing 21.5 x 28 mm with 8-pin and 14-pin blade socket.

Ordering Key

HAA 08 D M24

Housing _____
 Function _____
 Type _____
 Item number _____
 Output _____
 Power supply _____

Type Selection

Mounting	Output	Plug	Supply: 24 to 240 VAC/DC
Socket	DPDT	8-pin	HAA08DM24
Socket	4PDT	14-pin	HAA14QM24

Time Specifications

Time ranges Dip-switch selectable	0.1 to 1.0 s 1 to 10 s 0.1 to 1 min 1 to 10 min 0.1 to 1 hour 1 to 10 hour 10 to 100 hour
Setting accuracy	$\pm 5\%$ on full scale ± 200 ms
Repeatability	$\pm 0.3\%$ on full scale or ± 200 ms
Time variation Within rated power supply Within ambient temperature	$\leq 0.05\%$ /V $\leq 0.2\%$ /°C
Reset Power supply interruption	>100 ms

Output Specifications

Output Rated insulation voltage	DPDT or 4PDT relay 250 VAC
Contact ratings (AgCe) HAA08 (DPDT) Resistive loads AC 1 DC 12 Small inductive loads AC 15 DC 13	μ 8 A @ 250 VAC 8 A @ 30 VDC 2.5 A @ 250 VAC 2.5 A @ 30 VDC
HAA14 (4PDT) Resistive loads AC 1 DC 12 Small inductive loads AC 15 DC 13	5 A @ 250 VAC 5 A @ 30 VDC 1.5 A @ 250 VAC 1.5 A @ 30 VDC
Mechanical life	$\geq 1 \times 10^7$ operations
Electrical life	$\geq 10^5$ operations (HAA08: at 8 A, 250 VAC / 30 VDC, $\cos \varphi = 1$ HAA14: at 5 A, 250 VAC / 30 VDC, $\cos \varphi = 1$)
Operating frequency	≤ 18000 operations/h
Dielectric strength Dielectric voltage Rated impulse withstand volt.	≥ 2 kVAC (rms) 3.6 kV (1.2/50 μ s)



Supply Specifications

Power Supply Rated operational voltage through terminals: 13, 14	Overvoltage cat II (IEC 60947-1) 24 to 240 VDC + 10% - 15% 24 to 240 VAC + 10% -15%, 45 to 65 Hz
Rated operational power AC supply DC supply	4 VA 1.5 W

General Specifications

Indication for Power supply, relay and timing status	LED, yellow (steady with relay closed, flashing 10 Hz when timing with relay open, flashing 2 Hz after In function set time ending (relay open))
--	--

General Specifications (cont.)

Environment Degree of protection Operating temperature Storage temperature	IP 50 (front panel) -10 to +55 °C, R.H. < 85% -10 to +55 °C, R.H. < 85%
Housing Dimensions Material	21.5 x 28 mm PA66
Weight	Approx. 95 g
Approvals	UL (240 V 5A general use, 240 V 1/10 hp, all models) CSA (240 V 5A general use, 240 V 1/10 hp, all models)
CE marking	Yes
EMC Immunity Emission	Electromagnetic Compatibility According to EN 61000-6-2 According to EN 61000-6-3
Suitable socket HAA08 HAA14	ZMI2xx, ZMI4xx series ZMI4xx series

Mode of Operation

Function Op Delay on operate

The set delay period begins as soon as the power supply is connected. At the end of the set delay the relay operates and does not release until the power supply is interrupted for at least 100 ms.

Function R Symmetrical recycler (ON first)

The relay operates and the time period start as soon as the power supply is applied. At the end of the first set time period, the relay releases. At the end of the second time period (equal to the first), the relay operates again. This sequence continues with equal ON- and OFF- time periods until the power supply is interrupted for at least 100 ms.

Function Rb Symmetrical recycler (OFF first)

The time period begins as soon as the power supply is applied. The relay is OFF during the set delay period, after this time it operates for the same time period. This sequence continues with equal OFF- and ON-time periods until power supply is interrupted for at least 100 ms.

Function In Interval

The relay operates and the time period begins as soon as the power is applied. The relay releases at the end of the time period or when the power supply is disconnected for at least 100 ms.

Function/Range/Time Setting

Adjust the time range setting the DIP switches 1 to 3, the function setting the DIP switches 4 and 5 as shown below.

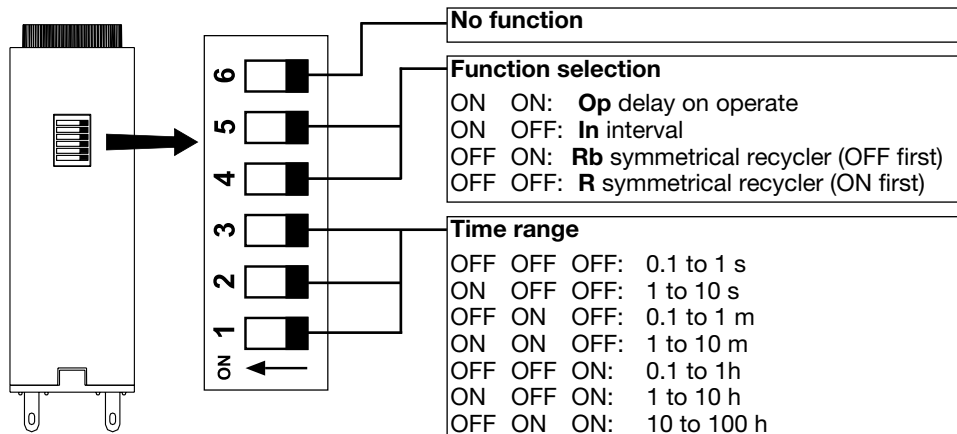

Centre knob:

Time setting on relative scale: 1 to 10 with respect to the chosen range.

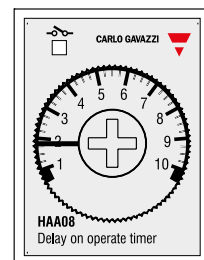

Operating Diagrams

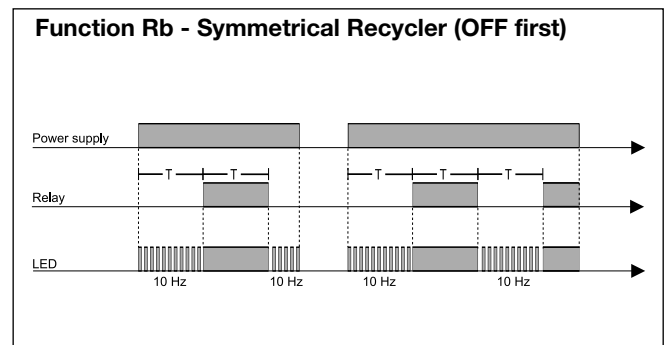
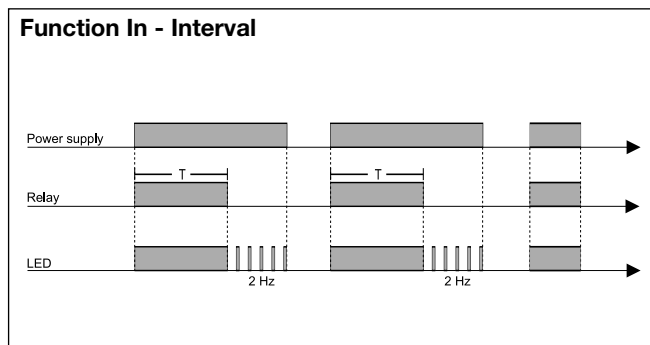
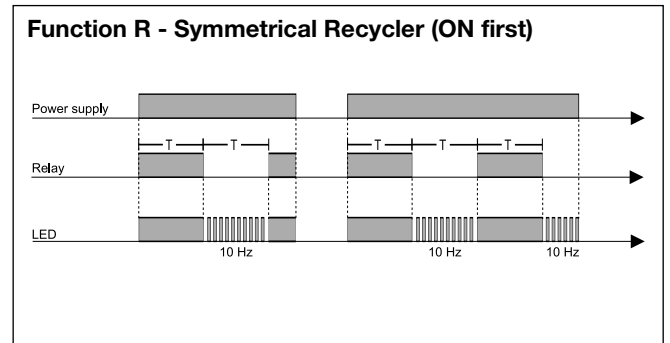
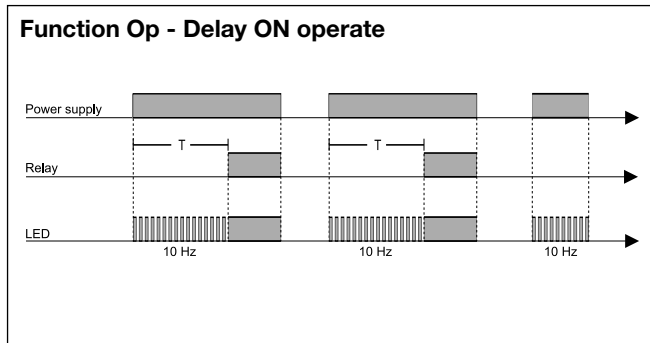

Wiring Diagrams

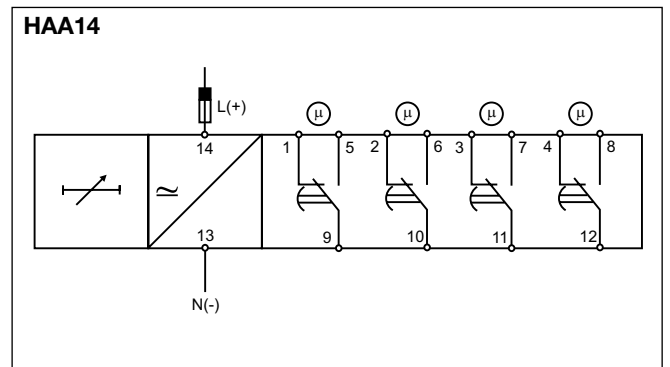
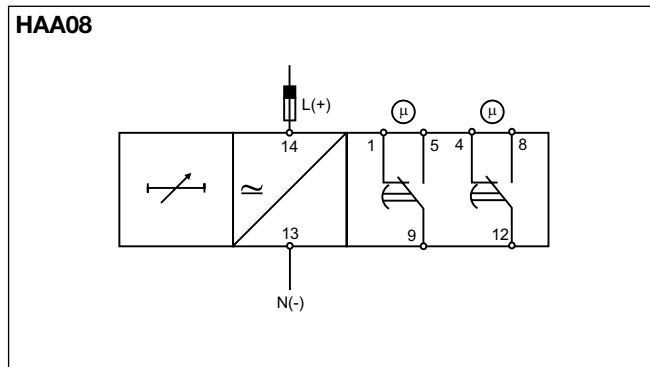

Dimensions

