

## FEATURES

- Two way shut-off valves for automatic control of air, inert gas, water, oil and other gases/liquids compatible with the seal materials used
- Heavy duty piston design for severe applications
- All products are covered by Pressure Equipment Directive 97/23/EC and are suitable for group 1 and 2 fluids
- The solenoid valves satisfy all relevant EC directives

## GENERAL

Differential pressure See «SPECIFICATIONS» [1 bar =100 kPa]  
Maximum viscosity 65 cSt (mm<sup>2</sup>/s)  
Response time 40 - 120 ms

fluids (*)	temperature range (TS)	seal materials (*)
air, inert gas, water, oil	-20°C to +90°C	NBR (nitrile) PTFE

## MATERIALS IN CONTACT WITH FLUID

(\*) Ensure that the compatibility of the fluids in contact with the materials is verified

	Brass body	Stainless steel body
Body	Brass	AISI 304 SS
Core tube	Stainless steel	Stainless steel
Core and plugnut	Stainless steel	Stainless steel
Springs	Stainless steel	Stainless steel
Seat	Brass	Stainless steel
Seals and core disc	NBR	NBR
Piston	PPS / brass / st. steel	PPS or brass
Piston disc	NBR or PTFE	NBR
Piston rings	PTFE (carbon filled)	PTFE (carbon filled)
Shading coil	Copper	Silver

## ELECTRICAL CHARACTERISTICS

Coil insulation class F or H F  
Connector Spade plug (cable Ø 6-10 mm) or cable leads, 0,35 m length (EF)  
Connector specification ISO 4400 / EN 175301-803, form A  
Electrical safety IEC 335  
Electrical enclosure protection Moulded IP65 (EN 60529) or NEMA 3, 7, 9 (EF)  
Standard voltages DC (=) : 24V - 48V  
AC (~) : 24V - 48V - 115V - 230V / 50 Hz  
(Other voltages and 60 Hz on request)

prefix option	power ratings				operator ambient temperature range (TS) (C°)	replacement coil		type <sup>(1)</sup>
	inrush ~	holding ~		hot/cold =		~	=	
	(VA)	(VA)	(W)	(W)		230 V/50 Hz	24 V DC	
SC	34	15,6	6	-	-20 to +75	400325-117	-	01
	-	-	-	9/11,2	-20 to +75	-	400425-142	02
	78	35	16,7	-	-20 to +50	400425-217	-	02
	110	33,6	15,4	12/16,8	-20 to +75	400525-117	400625-142	03
	240	43	20	-	-20 to +50	400525-217	-	03
EF	-	-	-	21/30,6	-20 to +25	-	074073-005D	04

<sup>(1)</sup> Refer to the dimensional drawings on the following page.

## SPECIFICATIONS

pipe size	orifice size	flow coefficient Kv		operating pressure differential (bar)								power coil (W)		catalogue number		options					
				min.	max. (PS)						brass					stainless steel	maintained man. operator	FPM	EPDM	CR	PTFE
					air (*)	water (*)	oil (*)	~	=	~											
Rp 3/8	9	1,3	21,7	0,35	9	3	-	-	-	-	6	11,2	SCE210C073	-	MO	V	E	J	-		
NPT 3/8				0,07	-	-	9	3	-	-	9	3	6	11,2	-	SCB210A036	MO	V	E	J	-
Rp 1/2	11	1,9	31,6	0,35	9	3	-	-	-	-	6	11,2	SCE210A015	-	MO	V	E	J	-		
NPT 1/2				0,07	-	-	9	3	-	-	9	3	6	11,2	-	SCB210A037	MO	V	E	J	-
<b>NC - Normally closed, brass piston, NBR seals and PTFE disc</b>																					
Rp 3/4	19	5,2	86,7	0	24	14	14	12	14	12	15,4	-	SCE210B026	-	MO	V	E	J	T		
											-	30,6	EFE210B026 <sup>(2)</sup>	-	MO	V	E	J	T		
Rp 1	25	11,6	193	0,7	20	16	20	14	20	14	16,7	16,8	SCE210B078	-	MO	-	-	-	-		
Rp 1 1/4	28	12,8	214	0,7	20	16	20	14	20	14	16,7	16,8	SCE210B080	-	MO	-	-	-	-		
Rp 1 1/2	32	19,3	322	0,7	20	16	20	14	20	14	16,7	16,8	SCE210B082	-	MO	-	-	-	-		
<b>NC - Normally closed, brass piston, NBR seals and discs</b>																					
Rp 1	25	11,6	193	0	20	-	8	-	8	-	20	-	SCE210B027	-	MO	V	E	J	T		
<b>NC - Normally closed, stainless steel piston, NBR seals and discs</b>																					
Rp 2	44	37	617	0,35	9	3	9	3	6	3	6	11,2	SCE210-100	-	MO	V	E	J	-		

<sup>(2)</sup> Valve to be mounted with solenoid vertical and upright for DC.

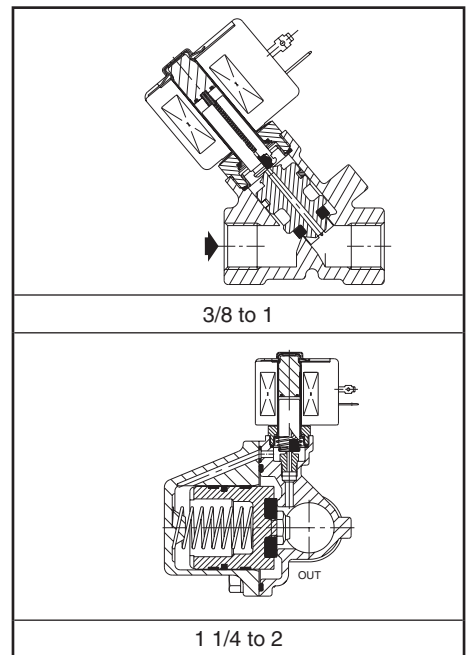

### OPTIONS

- Valves can also be supplied with FPM (fluoroelastomer), EPDM (ethylene-propylene), CR (chloroprene) and PTFE seals and discs. Use the appropriate optional suffix letter for identification
- Waterproof enclosure with embedded screw terminal coil according to protection class IP67, CEE-10
- Explosionproof enclosures for use in zones 1/21-2/22, categories 2-3 to ATEX Directive 94/9/EC (see "Explosionproof solenoids" section)
- Electrical enclosures according to "NEMA" standards are available
- Compliance with "UL", "CSA" and other local approvals available on request
- Mounting brackets, suffix MB (Except for SCE210B078/B080/B082/B027/-100)
- Other pipe connections are available on request
- Plug with visual indication and peak voltage suppression or with cable length of 2 m (see Solenoids, Coils & Accessories section)

### INSTALLATION

- The solenoid valves can be mounted in any position without affecting operation, unless indicated otherwise in the specifications table.
- Stainless steel valves are standard supplied with mounting brackets
- Pipe connection identifier is E = Rp (ISO 7/1) or B = NPT (ANSI 1.20.3)
- Installation/maintenance instructions are included with each valve

### SPARE PARTS KIT & ACCESSORIES

catalogue number	spare parts kit no.		mounting bracket no.
	~	=	
SCE210C073	C302271	C302371	093200-001
SCB210A036	C302327	C302421	093200-001
SCE210A015	C302275	C302374	100835-001
SCB210A037	C302326	C302422	100835-001
SCE210B026	C302278	-	038713-000
EFE210B026	-	C302377	038713-000
SCE210B078	C302281	C302380	-
SCE210B080	C302281	C302380	-
SCE210B082	C302285	C302384	-
SCE210B027	C302282	-	-
SCE210-100	C304355	C304359	-

(1) Standard prefixes/suffixes are also applicable to kits.  
- Not available

### ORDERING EXAMPLES:

SC	E	210	A	015	230V / 50 Hz
SC	E	210	B	026	MO 115V / 50 Hz
SC	B	210	A	037	V 24V / DC
SC	E	210	B	027	230V / 50 Hz

prefix      pipe thread      basic number      voltage      suffix

### ORDERING EXAMPLES KITS:

C302271 <sup>(1)</sup>	
C302374	V
C302278	E

basic number      suffix

### DIMENSIONS (mm), WEIGHT (kg)



**TYPE 01-02**  
Prefix "SC" Solenoid  
Epoxy moulded  
IEC 335 / ISO 4400  
IP65

Type 01, AC: SCE210C073/A015 - SCB210A036/037  
Type 02, DC: SCE210C073/A015 - SCB210A036/037

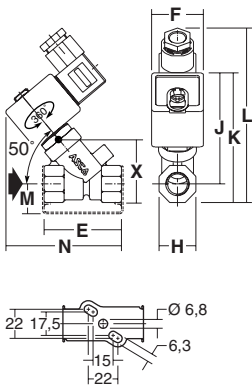

Type 01, AC: SCE210-100  
Type 02, DC: SCE210-100

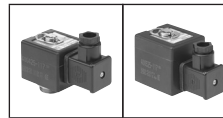
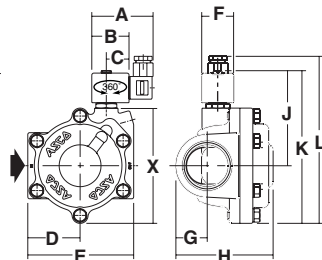

**TYPE 02-03**  
Prefix "SC" Solenoid  
Epoxy moulded  
IEC 335 / ISO 4400  
IP65

Type 02, AC: SCE210B078/B080/B082  
Type 03, DC: SCE210B078/B080/B082

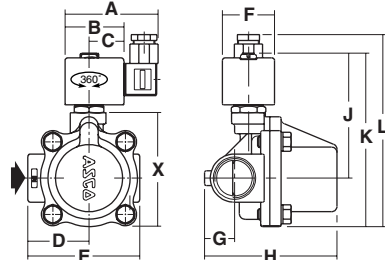

**TYPE 03**  
Prefix "SC" Solenoid  
Epoxy moulded  
IEC 335 / ISO 4400  
IP65

AC: SCE210B026/027

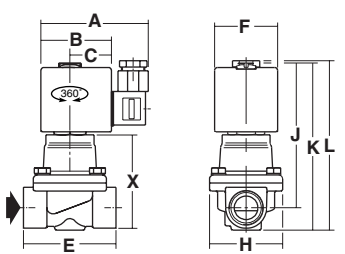

**TYPE 04**  
Prefix "EF" Solenoid  
Epoxy encapsulated  
ICS-6 ANSI  
NEMA type 3, 7, 9

DC: EFE210B026

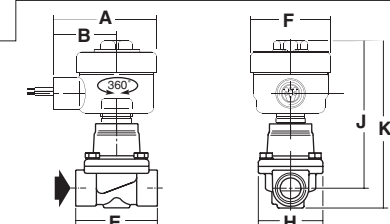

type	prefix option	catalogue number	A	B	C	D	E	F	G	H	J	K	L	M	N	X	weight <sup>(2)</sup>
01	SC	SCE210C073/A036	-	-	-	-	48	39	-	22	74	85	124	22	72	41	0,6
		SCE210A015/A037	-	-	-	-	58	39	-	28	82	95	128	22	89	47	0,6
		SCE210-100	75	45	27	64	129	39	39	120	116	186	203	-	-	149	5,5
02	SC	SCE210C073/A036	-	-	-	-	48	45	-	22	80	91	130	22	80	41	0,6
		SCE210A015/A037	-	-	-	-	58	45	-	28	82	95	128	22	93	47	0,6
		SCE210-100	80	50	30	64	129	45	39	120	120	190	207	-	-	149	5,5
		SCE210B078	80	50	30	55	95	45	45	108	55	154	149	-	-	95	2,8
		SCE210B080	80	50	30	52	95	45	30	119	108	149	166	-	-	117	3,0
SCE210B082	80	50	30	52	111	45	33	148	112	162	179	-	-	108	4,2		
03	SC	SCE210B078	86	56	33	55	95	50	50	108	55	154	152	-	-	95	2,8
		SCE210B080	86	56	33	52	95	50	30	119	114	156	156	-	-	97	3,0
		SCE210B082	86	56	33	52	111	50	33	148	118	165	165	-	-	110	4,2
		SCE210B026	86	56	33	-	74	50	-	59	117	133	135	-	-	76	1,3
		SCE210B027	86	56	33	-	100	50	-	33	50	83	143	-	-	84	2,5
04	EF	EFE210B026	83	51	-	-	74	64	-	59	117	133	135	-	-	-	1,3

(2) Incl. coil(s) and connector(s)

All leaflets are available on: [www.asconumatics.eu](http://www.asconumatics.eu)